

# INSTRUCTION MANUAL

## Wi-Fi Push button/Normal Switch Module

QS-WIFI-S08-16A-U

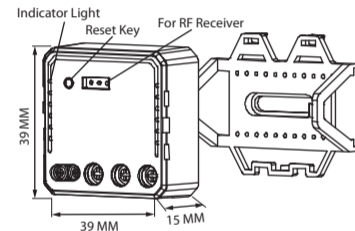

RoHS



### TECHNICAL SPECIFICATIONS

Product type	Wi-Fi Push button/Normal Switch Module
Voltage	100-240V AC
Current:	16A
Max. load	3680W/300W for LED
Operation frequency	2.4GHz~2.4835GHz WiFi 802.11 b/g/n
Operation temp.	-10°C - +40°C
Operation range	≤ 200 m
Dims (WxDxH)	39X39X15 mm
IP rating	IP20
Warranty	2 years
Certificates	CE ROHS

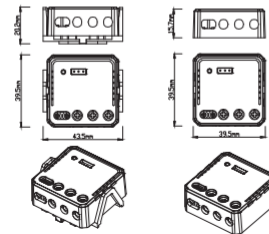

Global international operation Whenever & Wherever  
You are, All-in-one Mobile App

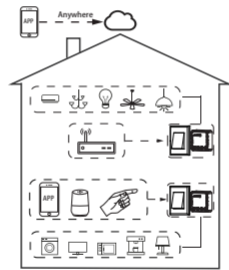

Inhouse local operation

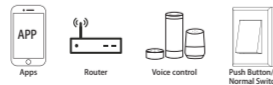

### INSTALLATION

#### ▲ Warnings:

1. Installation must be carried out by a qualified electrician in accordance with local regulations.
2. Keep the device out of reach of children.
3. Keep the device away from water, damp or hot environment.
4. Install the device away from strong signal sources such as microwave oven that may cause signal interruption resulted to abnormal operation of the device.
5. Obstruction by concrete wall or metallic materials may reduce the effective operation range of the device and should be avoided.
6. Do NOT attempt to disassemble, repair or modify the device.

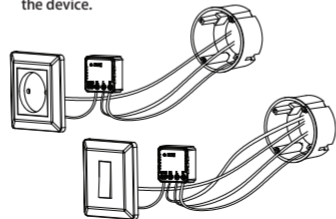

### MANUAL OVERRIDE

The switch module terminal reserves the access of manual override function for the end-user to switch on/off.

- Switch on/off for permanent on/off function.

Notes:

- 1) Both the adjustment on App and switch can override each other, the last adjustment remains in memory.
- 2) The App control is synchronized with the manual switch.

For Normal Switch

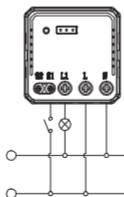

For push button switch

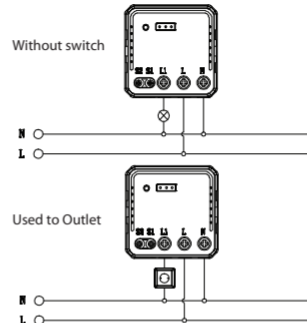
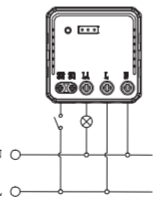

Wiring Instructions and Diagrams

1. Turn off the power supply before carrying out any electrical installation work.
2. Connect wires according to the wiring diagram.
3. Insert the module into the junction box.
4. Turn on the power supply and follow switch module configuration instructions.

Notes: Take your smartphone close to the switch module when you're configuring, and make sure you have min. 50% Wi-Fi signal.

### FAQ

- Q1: What should I do if I can't configure the switch module?
- a. Please check whether device is powered on.
  - b. Make sure your mobile and switch module are under the same 2.4 Ghz WIFI network.
  - c. Whether it's in good internet conditions.
  - d. Make sure the password entered in App is correct.
  - e. Make sure the wiring is correct.

Q2: What device can be connected to this Wi-Fi switch module?

Most of your household electrical appliances can be, such as lamps, laundry machine, coffee maker, etc.

Q3: What happens if the WIFI goes off?

You can still control the device connected the switch module with your traditional switch and once WIFI is active again the device connected to module will connect automatically to your WIFI network.

Q4: What should I do if I change the WIFI network or change the password?

You have to re-connect our Wi-Fi switch module to the new Wi-Fi network accordingly as per the App User Manual.

Q5: How do I reset the device?

1. Turn on/off manual switch which is connected to the device until the indicator light flash quickly.
2. Power on/off device for 5 times until the indicator light flash.
3. Long press the reset key for about 10 seconds until the indicator light flash quickly.

### APP USER MANUAL



IOS APP / Android APP

1

Scan the QR code to download Tuya Smart App, or you can also search keyword "Tuya Smart" at App Store or Googleplay to download App.

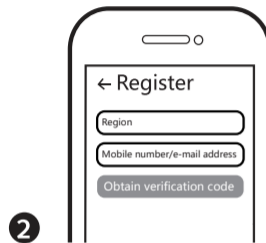

2 Log in or register your account with your mobile number or e-mail address. Type in the verification code sent to your mobile or mail box, then set your login password. Click "Create Family" to enter into the APP.

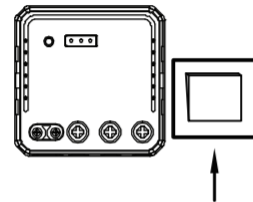

3 After the wiring of switch module is done, press the traditional switch to turn ON/OFF cycle for 5 times (keep time interval not too short) until the indicator light flash for pairing mode.



4 **Open Bluetooth on Mobile phone first**, then open the App, selecting "+" on top right, you will see "Devices to be added", click "Go to add". Remark: If we don't open Bluetooth, the device also can be searched, but it's slower.



5 Make sure your smart phone and Wi-Fi Switch are under the same Wi-Fi network at 2.4GHz. Choose the devices that need to be added, and click "+" to next step, and then enter Wi-Fi and password, finally confirm it.

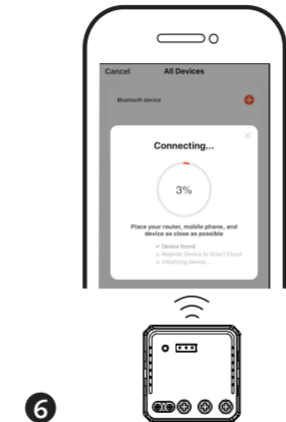

6 The pairing usually will be finished soon. Pls make your mobile phone and device as close as possible.

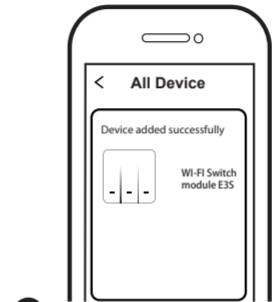

7 When pairing is done, the Wi-Fi switch will be shown on the App.



8 Connect to amazon alexa or Google Assistant for voice control, or share the devices with your families or friends.

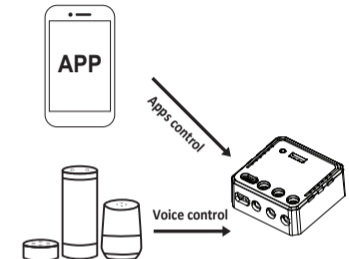

9 Enjoy your smart life of home automation for lighting control by using our All-in-one mobile app wherever you are in the world or simply by voice control when you are sitting at home comfortably.