



1. Technical Specifications

Product type	WIFI Slim Down Light
Mains voltage	220-240VAC 50Hz
Current	120mA
Load	15W
Operation frequency	2.4 GHz - 2.483 GHz
Color	CCT 3000k-6000K adjustable
IP rating	IP44
Insulation	Class II
Other Protocol	Bluetooth
Test standards	EN301489 EN62311 EN55015 EN61547 EN60669 IEC60669

2. Main Features

1. Work with Amazon Alexa/ Echo Dot & Google Home & IFTTT.
2. Manage your devices via your mobile phone or Voice Control.
3. Short-circuit Protection, Over-voltage Protection and Over-temperature Protection
4. Reset - Power on/off for 5 times until the light flashing, then the light is now ready for synchronization.

3. Installation

⚠ Warnings:

1. Installation must be carried out by a qualified engineer in accordance with local regulations.
2. Disconnect power supply before installing.
3. Ensure environmental conditions are suitable for electronic equipment.
4. Keep the device out of reach of children.
5. Do NOT clean with liquid.
6. Keep the device away from water, damp or hot environment.
7. Do NOT exceed the recommended electrical ratings.

Product Size

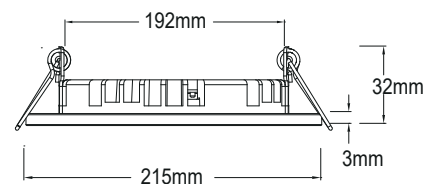

8. Install the device away from strong signal sources such as microwave oven that may cause to signal interruption resulted to abnormal operation of the device.
9. Obstruction by concrete wall or metallic materials may reduce the effective operation range of the device and should be avoided.
10. Do NOT attempt to disassemble, repair or modify the device.

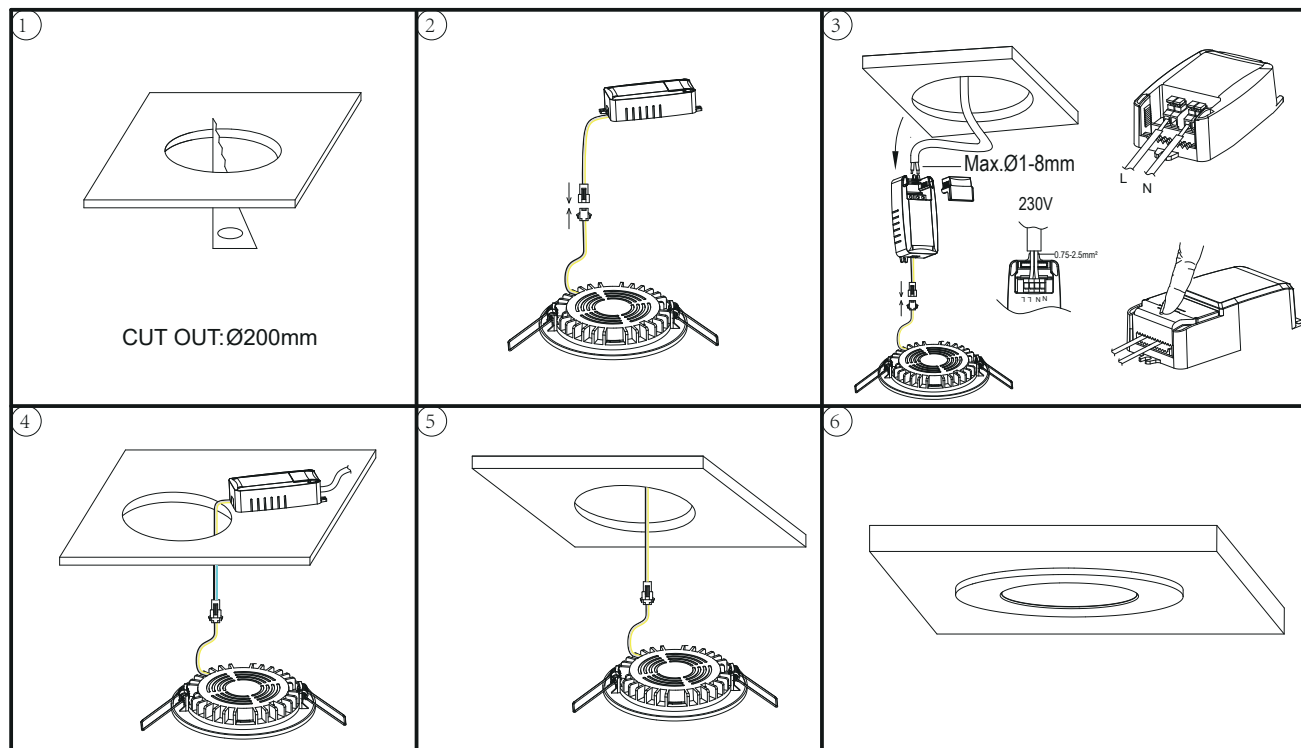

4. THINGS TO KNOW BEFORE USING WI-FI LED Light

- Make sure your router is configured to 2.4G, and your Smartphone is connected to this 2.4G network
- Make sure you have a strong Wi-Fi signal at the WI-FI LED Light.
- Make sure the "AP isolation/Access point" function is deactivated on your router.
- Wi-Fi LED Slim Light needs to be set up again if the SSID or password is changed.
- Make sure no extra log in page is required in the browser after your device is connected to Wi-Fi

5 .App User Manual



iOS APP/Android APP

1

Scan the QR code to download Tuya Smart App at App Store or Smartphone. You can also search keyword "Tuya Smart" at App Store or Googleplay to download App.

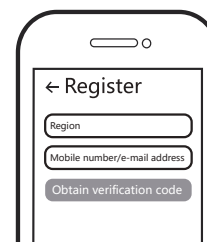

2

Register your account with your mobile number or e-mail address, wait a few minutes for verification code (by text message or e-mail) and enter it where required to set a password, and "Create Family". If you have account, please log in directly with your Mobile number or e-mail address with password to open the app under Wi-Fi 2.4GHz connection.

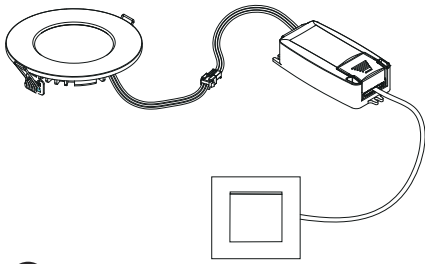

3

Switch the on/off button for 5 times until the light connected to the driver is flashing, then the light connected to the driver ready for pairing.

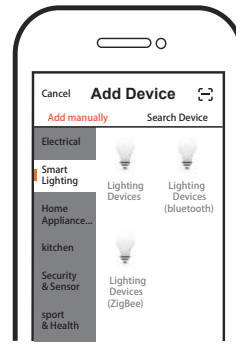

4

Open the App,select "+" on the top right of the home page to add device.At the net-pairing,select the type of product,here is "Smart Lighting" as sample.



5

Make sure your smart phone and Wi-Fi switch module are under the same Wi-Fi network at 2.4GHz connection.Confirm when the light blinks rapidly(twice a second).



6

Select the Wi-Fi through which the device can connect to the internet,and enter the Wi-Fi password.Then click "OK" to proceed to net-pairing.

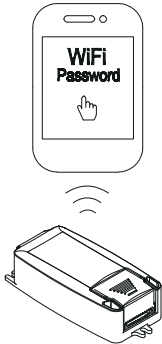

7

The connecting will take about 10-120 seconds to complete depending on your network condition.

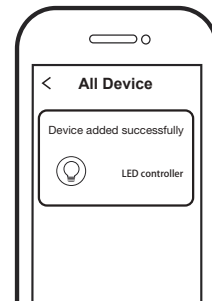

8

When pairing is done,the LED Light will be shown on the App.

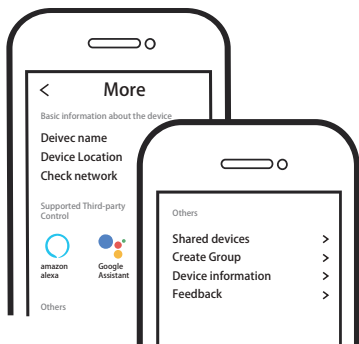

9

Connect to amazon alexa or Google Assistant for voice control,or share the devices with your families or friends.

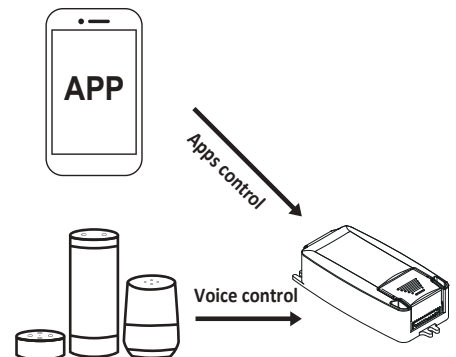

10

Enjoy your smart life of home automation for lighting control by using our All-in-one mobile app wherever you are in the world or simply by voice control when you are sitting at home comfortably.