



FEATURES

- Input 100-265V AC
- 12W / 18W / 24W / 30W
- CRI(Ra)>80
- Power factor, 0.95
- White finish
- Uniform luminance
- No glare
- 120° beam angle
- More than 50,000hrs' lifetime
- No lead, no mercury

SPECIAL POINTS

- Side lighting
- Light is bright and even, friendly to eyes
- High quality driver with high efficiency and high PF

APPLICATIONS:

- Corridor
- Living room
- Staircase
- Household
- Hall
- Art gallery
- Museum
- Office
- Shopping mall
- Hotel
- Hospital, etc.

Mechanical

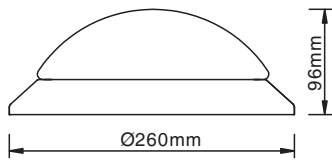

Model: QS-NC-CL12W

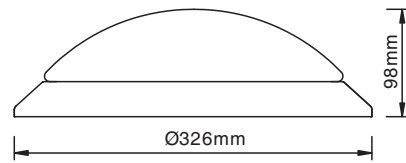

Model: QS-NC-CL18W

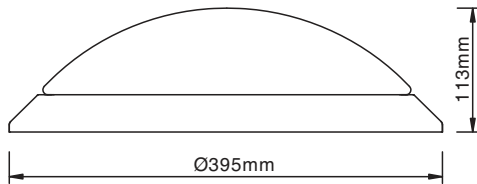

Model: QS-NC-CL24W

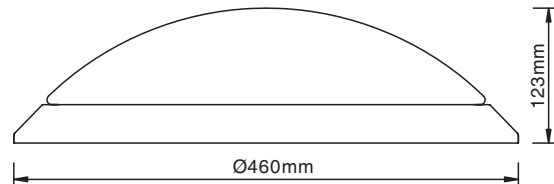

Model: QS-NC-CL30W

General

Model	QS-NC-CL12W	QS-NC-CL18W	QS-NC-CL24W	QS-NC-CL30W
Power Consumption(W)	12W	18W	24W	30W
Lumen	60lm/W	70lm/W	80lm/W	80lm/W
Input Voltage	100-265V AC			
Light Source	0.5W SMD LED			
Color Temperature(CCT)	3000K / 4000K / 6000K			
CRI (Ra)	>80			
Beam Angle	120°			
Material	Steel / aluminum base with PMMA diffuser			
Fixture Color	White			
IP Grade	IP 21			
Environment	Indoor use			
Operation Temperature	Max Ta=45°C			
Lifespan	50,000hrs			
Certification	CE, RoHS, SAA			
Warranty	3 years			

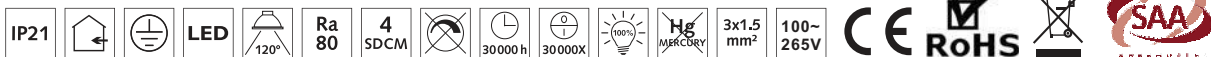

Goniophotometers System Test Report

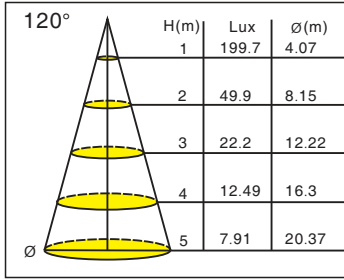

Model: QS-NC-CL12W

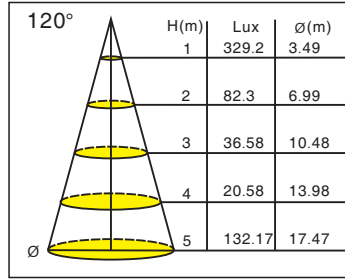

Model: QS-NC-CL18W

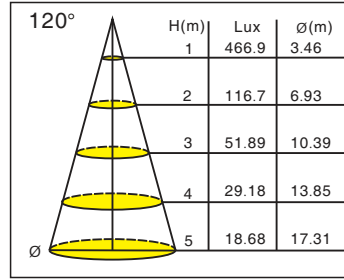

Model: QS-NC-CL24W

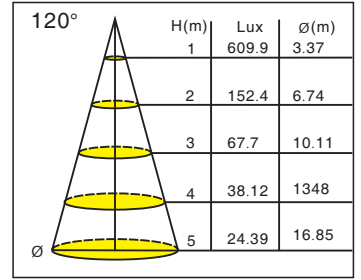

Model: QS-NC-CL30W

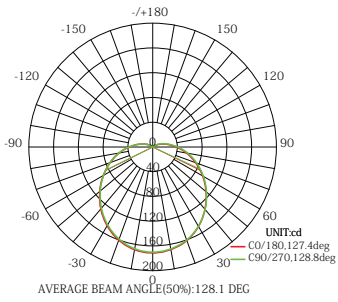

Model: QS-NC-CL12W

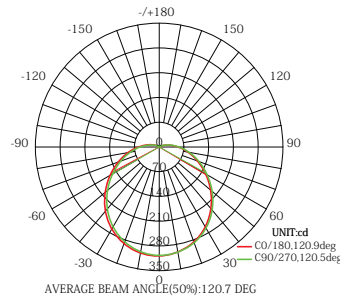

Model: QS-NC-CL18W

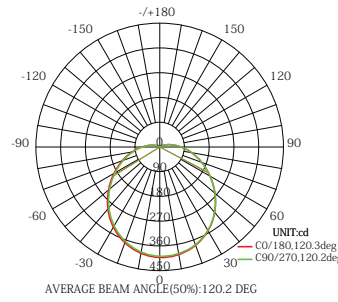

Model: QS-NC-CL24W

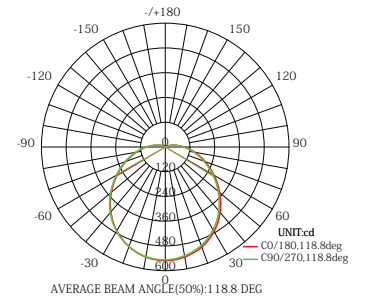

Model: QS-NC-CL30W

Installation

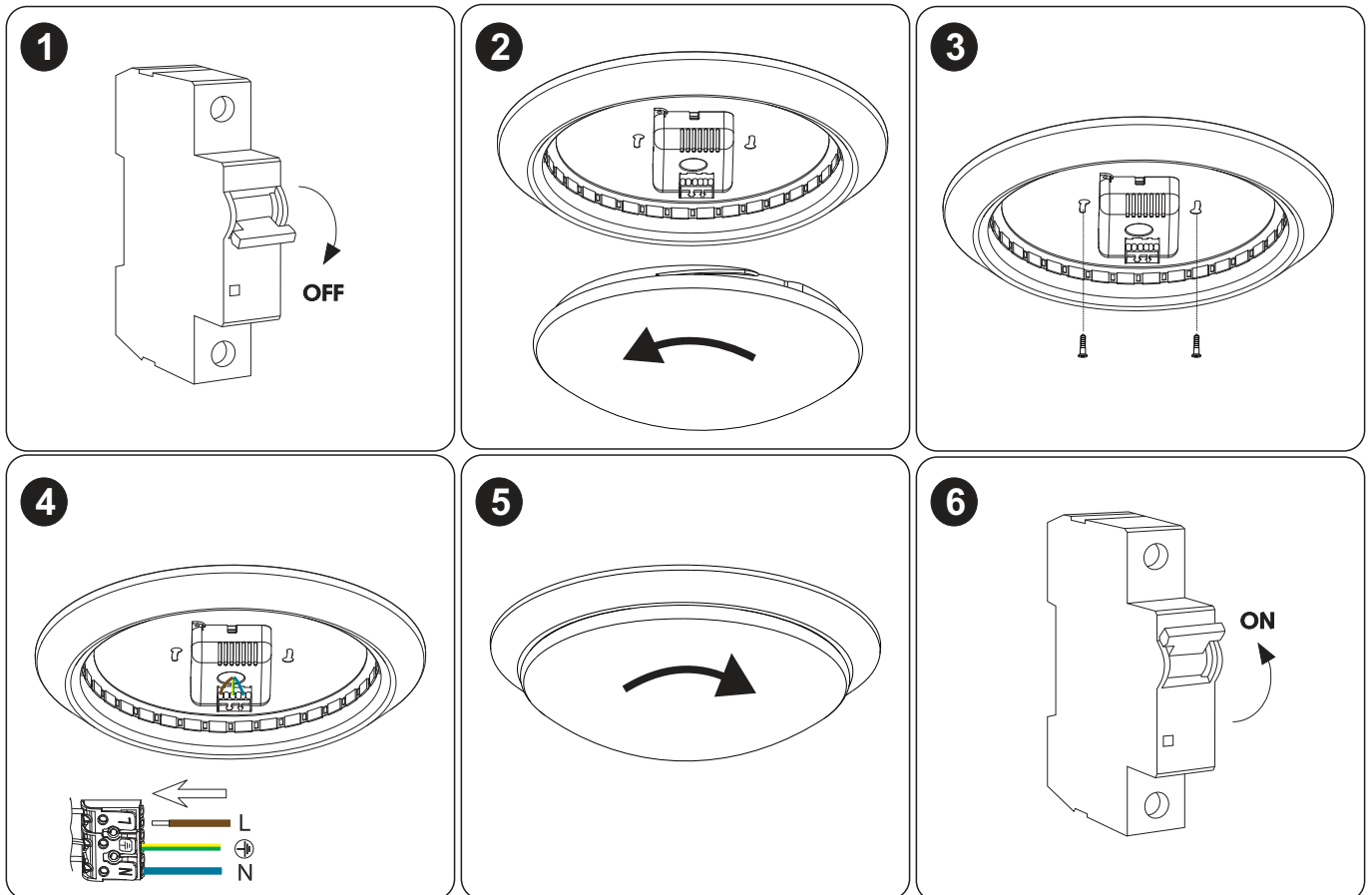

Packaging

Model	QS-NC-CL12W	QS-NC-CL18W	QS-NC-CL24W	QS-NC-CL30W
Packaging Measurement	Master Carton	Master Carton	Master Carton	Master Carton
Unit per Carton	10pcs	10pcs	5pcs	5pcs
Dimension	67*56*35cm	89*59*42cm	66*50*50cm	72*55*55cm
Net Weight/Gross Weight	9.8kgs/11.5kgs	12.2kgs/14.8kgs	8.1kgs/10.35kgs	10.3kgs/13.1kgs

Warranty

Quality LED Warrants to its customers who purchase its LED fixtures that the products are free from defects in material and workmanship from the date of shipment. During warranty period, Quality LED, at their discretion, agrees and shall be obligated to a limit of refund of the purchase price of the products or replacement of fixtures.

This limited warranty will not apply to loss or damage to the product caused by: damage due to fire or acts of God; vandalism; civil disturbances; accident; failure to follow installation, operating or maintenance. This limited warranty excludes field labor and service charges related to the repair or replacement of the Product.

Complete warranty details for fixtures are available. Please contact our salesperson.